

Référence : 021 494-46

## Rail en acier pour portail autoportant

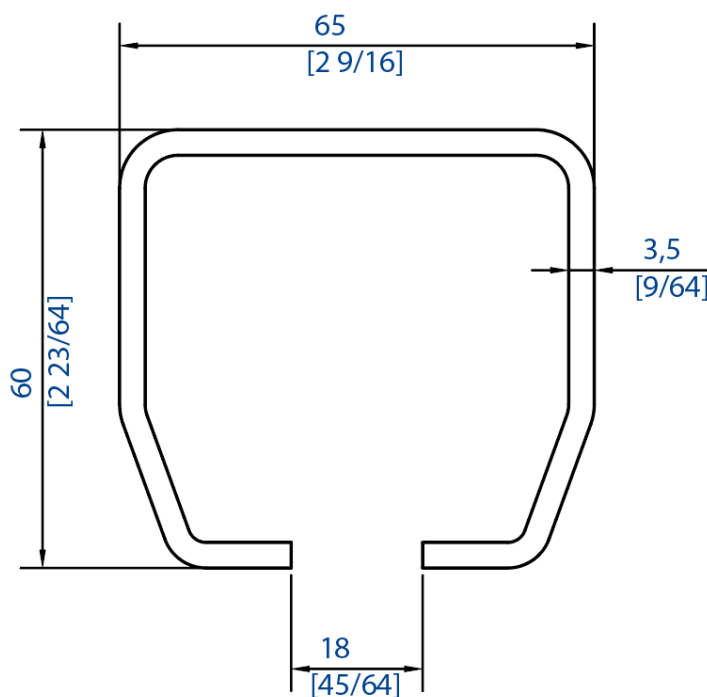
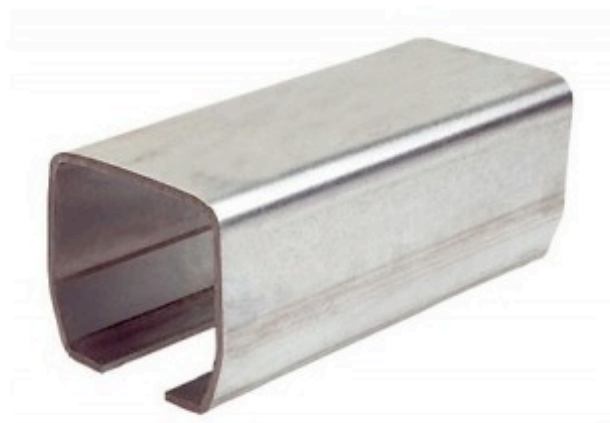

Longueur	Profil	Capacité de charge
6 m	65x60	275 kg